



SPECIFICATION FOR APPROVAL

CUSTOMER : ARCERA EU

MODEL NO : 6025 (CeraDyna Fan)

PART NO : FD1260-AP581E2AL

DATE : 2011.4.26

CUSTOMER APPROVAL

Taiwan	
ACT-RX TECHNOLOGY CORPORATION	TEL: 886-2-82421111
2F, No.192, Lian Cheng Road, Zhonghe Dist.,	
New Taipei City 235, Taiwan (R.O.C.)	FAX: 886-2-82452200

Approved	QC	Checked	Checked	Prepared

CONTENTS

1. <u>SCOPE</u>	3
2. <u>ELECTRICAL</u>	3
3. <u>MATERIAL</u>	4
4. <u>MECHANICAL</u>	4
5. <u>EXPECTED LIFE SPAN (MTTF)</u>	4
6. <u>NOISE MEASUREMENT</u>	5
7. <u>RELIABILITY</u>	6-7
8. <u>PRODUCT LABEL</u>	7
9. <u>PERFORMANCE CHART</u>	8
10. <u>ASSEMBLY DIAGRAM</u>	9
11. <u>SPEED VS PWM CONTROL SIGNAL</u>	10
12. <u>ORDERING AND OPERATING REMARKS</u>	11
13. <u>FAN PACKING DATA</u>	12

1. SCOPE

This document is a specification defining the electrical and mechanical characteristics of the product.

2. ELECTRICAL

Standard operating condition is 25°C, 65%RH ambient, unless otherwise specified.

	Item	Specification	Test Condition
1	Rated Voltage	12V	DC power supply
2	Rated Current	0.47 Amp (Typical) Max0.55 Amp(SafetyRegulation)	DC power supply at Rated Voltage This is for Safety Regulation.
3	Rated Power	5.64 W	At Rated Voltage.
4	Starting Voltage	10.8V (Min.)	DC power supply
5	Insulation Resistance	10MΩ (Min.)	Input 500V(DC) between Lead wire(+) and housing
6	Speed	6500 RPM ±10%	Measured at 5 minutes after starting under 25±5°C, 65± 5%RH ambient
7	Acoustical Noise	53.90 dB(A) (measurement tolerance ± 2 dBA)	Measured at typical speed with an acoustic microphone 1 meter away from the fan intake in a test chamber with background noise level below 18dB(A) under ISO-3745 Standard, refer to NOISE MEASUREMENT ITEM 7.
8	Static Pressure	11.17 mm-H ₂ O (0.44 inch-H ₂ O)	Refer to PERFORMANCE CHART ITEM 9 at zero airflow. This measurement is performed AMCA 210-99 Standard.
9	Air Flow	39.42 CFM (1.12CMM)	Refer to PERFORMANCE CHART ITEM 9 at zero static Pressure. This measurement is performed AMCA 210-99 standard.
10	Direction of rotation	Counter- anticlockwise	DC power supply, viewed from impeller.

3. MATERIAL

Impeller	PBT UL94-V0
Frame	PBT UL94-V0
Bobbin	PBT UL94-V0
Lead Wire <input checked="" type="checkbox"/> + : Red <input checked="" type="checkbox"/> - : Black <input checked="" type="checkbox"/> : PWM <input checked="" type="checkbox"/> O/P: <input checked="" type="checkbox"/> White <input type="checkbox"/> Yellow	UL 1007 AWG <input type="checkbox"/> 24 <input type="checkbox"/> 26 <input checked="" type="checkbox"/> 28

4. MECHANICAL

Dimensions	L * W * H =60*60*25 (mm)
Weight	75 grams
Standard operating temperature range	-10 °C ~ 75 °C
Standard storage temperature	-20 °C ~ 80 °C
Bearing system	<input type="checkbox"/> Two Ball Bearing <input type="checkbox"/> One Ball One Sleeve Bearing <input type="checkbox"/> Sleeve Bearing <input checked="" type="checkbox"/> Alloy Sleeve with Ceramic Shaft <input type="checkbox"/> Ceramic Bearing with Ceramic Shaft

5. EXPECTED LIFE SPAN (MTTF)

At a standard operating condition of 25±5°C, 65±5%RH ambient, the expected life(expressed as Mean Time To Failure) of products are evaluated under MIL-STD-781 Standard as below :

- Two Ball Bearing : 65000 hrs , Continuous operating under 25°C 65%RH
- One Ball One Sleeve Bearing : 50000 hrs , Continuous operating under 25°C 65%RH
- Sleeve Bearing : 30000 hrs , Continuous operating under 25°C 65%RH
- Alloy Sleeve with Ceramic Shaft : 300000 hrs , Continuous operating under 25°C 65%RH
- Ceramic Bearing with Ceramic Shaft : 500000 hrs , Continuous operating under 25°C 65%RH

6. NOISE MEASUREMENT :

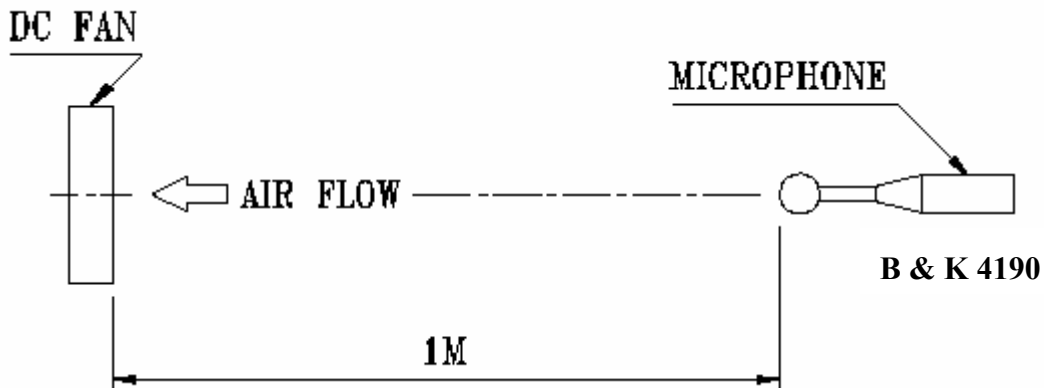

Noise is measured under Rated Voltage in free air in the anechoic chamber with B & K Nexus 4350 conditioning amplifier, with B & K 4190 microphone at a distance of one meter from the fan intake. The background noise is 18dBA max under the ISO-3745 Standard.

7. RELIABILITY

	Item	Specification	Test Condition
1	Locked Rotor Test	Flameproof and damage free	Rotor locked for 72 hrs with Rated Voltage
2	Reverse Voltage Test Protection	Yes	Reverse 15 min with Rated Voltage
3	Balance Test	No protruding beyond the circle within 10 seconds	The fan runs in a circle, scaled by fan radius plus 20mm, on a perfectly smooth plate for 10 seconds under the ISO 1940 G6.3 grade Standard.
4	Drop Test	All specified characteristics remain unchanged	Drop D.U.T.(The standard packing) from the test machine at 76cm below. Individual one angle, three diagonal corners and six planes under the IEC 68-2-31 Standard.
5	Vibration Test	All specified characteristics remain unchanged	Ambient temp. : 25 °C±5 °C with Rated Voltage Amplitude : 0.4-2.5 mm Acceleration : 14.7 S/m ² Frequency : 10HZ-60HZ Sweeping period : 11 min 10HZ-60HZ : 10 min 60HZ-10HZ : 10 min Total : 10 cycles This test is under the IEC 68-2-6 Standard.
6	High/Low Temperature Cycling	All specified characteristics remain unchanged	20 minutes slew rate +75 °C (12 hr) , -20 °C (12 hr) Total : 25 cycles with Rated Voltage This test is under IEC 68-2-38 Standard.
7	Low Temp. Test	All specified characteristics remain unchanged	Tested under standard condition ; after 500hrs, -25 °C, with power supply. This test is under IEC 68-2-1 Standard.

8	High Temp. Test	All specified characteristics remain unchanged	Tested under standard condition ; after 500hrs, 80 °C, with power supply. This test is under IEC 68-2-2 Standard.
9	Hi Pot Test	All specified characteristics remain unchanged	Input 500V(AC) for 1 min between lead(+/-) and housing. This test is under CNS-C6013 Standard.

8. PRODUCT LABEL



9. PERFORMANCE CHART

This measurement is according to the AMCA 210-99 Standard.

PQ curve for FD1260-AP581E2AL under Rated Voltage.

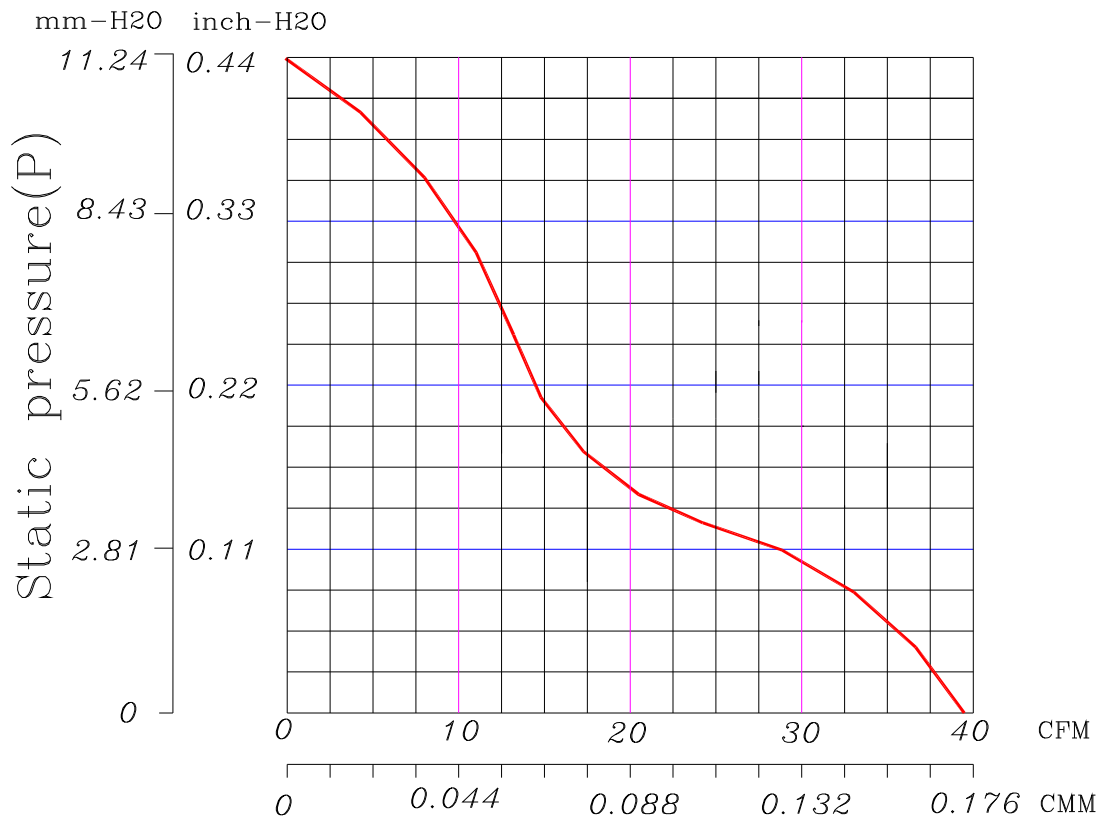

10.ASSEMBLY DIAGRAM

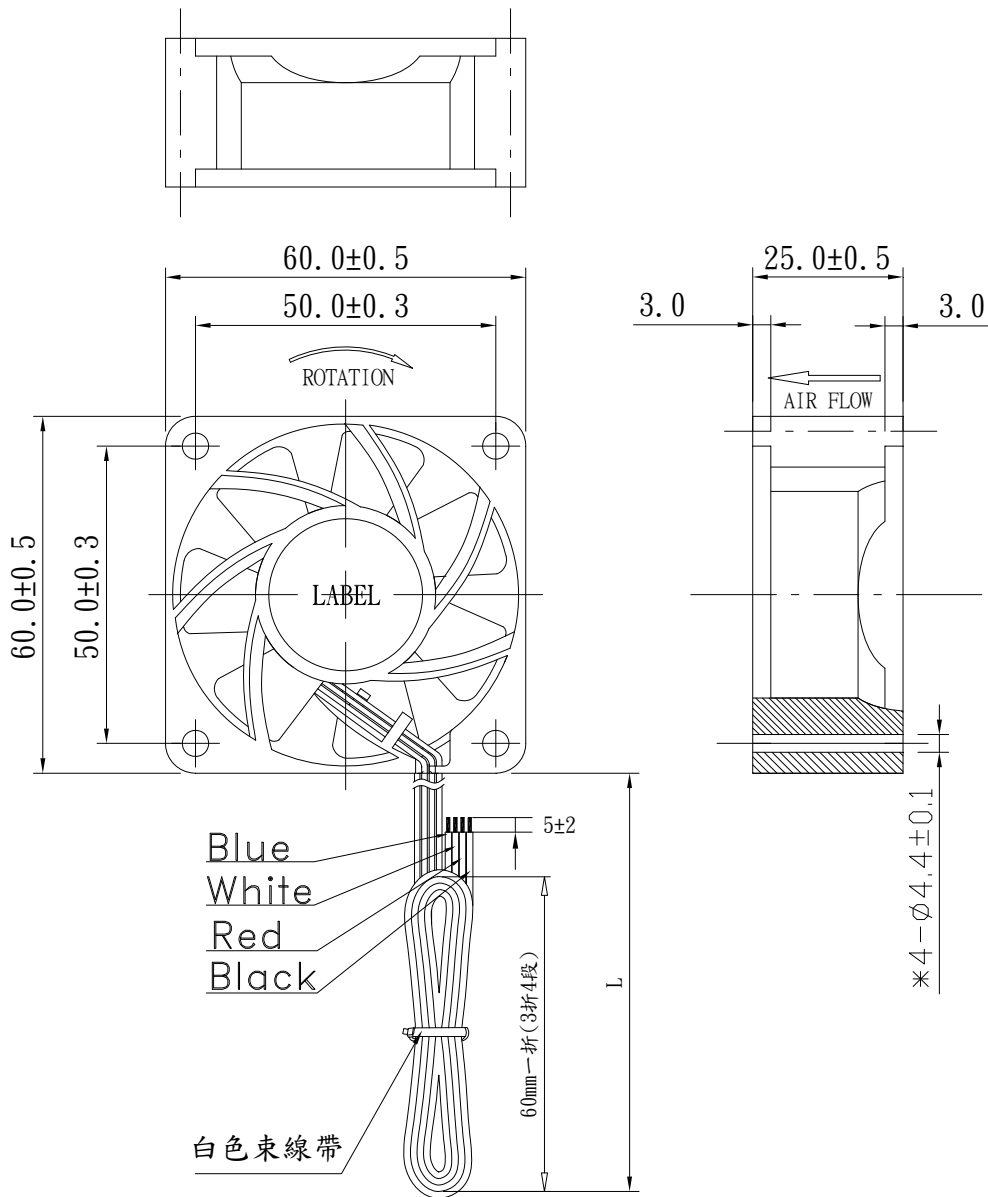

General Dimension.Tolerances (Unit:mm)		
0-3	±	0.3
3-30	±	0.4
31-60	±	0.5
61-100	±	0.6
101 and Over	±	0.6
Angles	±	2°

Note :

L* : Lead wire length : 295 ± 10 mm (From frame edge)

11.SPEED VS PWM CONTROL SIGNAL :

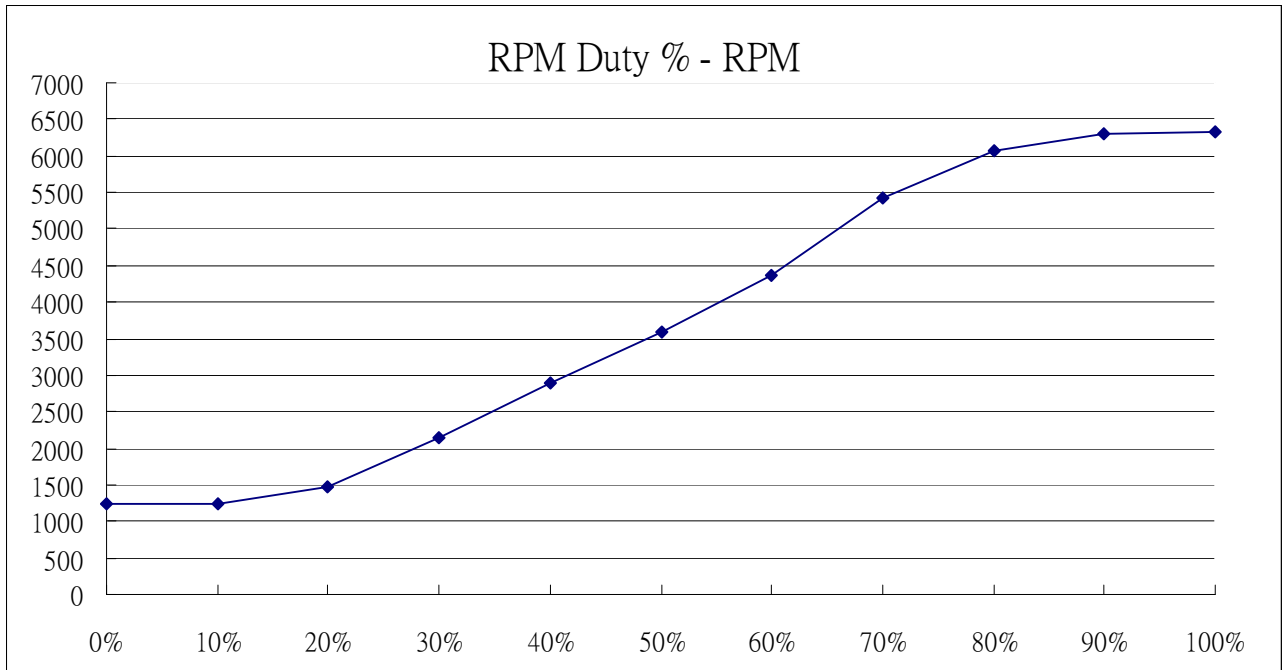

Parameter	
PWM input H level	3~5V
Input frequency	20kHz-30kHz

12. ORDERING AND OPERATING REMARKS

12.1 Please indicate Part No. on every order.

12.2 For those not specified but vital to your requirement, ACT-RX is in full position to supply qualified substitutes.

12.3 ACT-RX does not guarantee the product if applications exceed specified limitations.

12.4 Please do not touch the impeller and never carry the fan the lead wires. The bearings and the lead wires may be damaged.

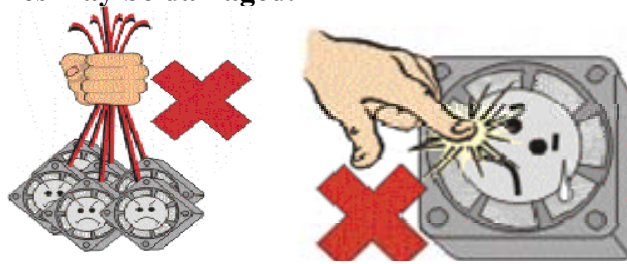

12.5 Please do not use the fan in the environment of corrosive gas or liquid.

12.6 Please do not store the fan in the environment of high humidity. Please avoid storage of the fan over 6 months . For long term storage, please connect power to the fan shortly every 6 months even through the fan is stored in room temperature.

12.7 Improper use may lead to malfunction. To ensure normal operation, avoid dipping the fan into watery and oily liquid, or exposing it to heat, etc.

12.8 Please do not lock the rotor for those fan models without Auto Restart function during operation to prevent over heating which may cause permanent damage.

12.9 Warrantee period is 12 months max. under the environment condition IP-20 specified in IEC60529.

12.10 All specifications subject to change without prior notice.

13.FAN PACKING DATA



fan: 60mm*60mm*25mm

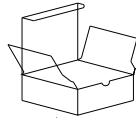

box: 68mm*62mm*34mm
1fans/box

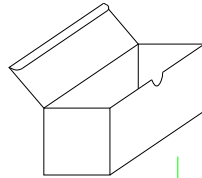

box: 339mm*149mm*79mm
20fans/box

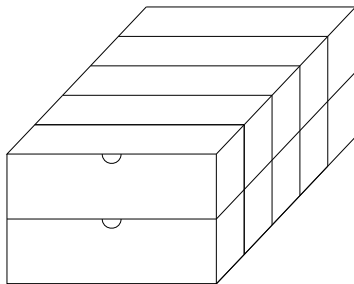

10boxes

carton: 385mm*336mm*445mm
10boxes/carton
200fans/carton
10.91KG/NET weight

